

The purpose of the information in this presentation is to guide ICA programs and provide members with information to make independent business decisions.

Antitrust Guidelines for Copper Industry Trade Association Meetings

The following guidelines with respect to compliance with antitrust laws of the United States, Japan and European Community¹ are intended to govern the conduct of participants in copper industry trade association meetings, both at the meeting itself and in informal discussions before or after the formal meeting.

Price: Competitors should not discuss future prices (including terms of sale) of their products. There is no blanket prohibition against the mention of or reference to current or past prices but limits must be observed. Such references or mentions should occur only when necessary in connection with the development of association programs. For example, reference to a particular price level in comparing the cost of a copper product to a competing product is permitted. Whenever possible, such references should be discussed in advance with legal counsel.

Competitive Information: Competitors should not discuss the market share of a particular copper producer or copper fabricator's products. Furthermore, nothing should be said at a meeting which could be interpreted as suggesting prearranged market shares for such products or producer production levels. The overall market share of copper products may be discussed with regard to competition with non-copper products and general market acceptance.

New Products: Competitors should not encourage or discourage the introduction of a new product by another competitor or reveal a particular copper company's plans to change the production rate of an existing product or to introduce a new product. No company should disclose to another company whether it is in a position to make or market a new product. New products may be discussed in a technical manner or from the standpoints of competition with non-copper products and general market acceptance. In addition, proposed methods for and results of field and laboratory testing can be considered.

The Role of Legal Counsel: Legal counsel attends association meetings to advise association staff and other meeting attendees regarding the antitrust laws and to see that none of the matters discussed or materials distributed raise even the appearance of antitrust improprieties. During the course of a meeting, if counsel believes that the discussion is turning to a sensitive or inappropriate subject, counsel will express that belief and request that the attendees return the discussion to a less sensitive area.

A paper entitled 'Copper Industry Trade Associations and Antitrust Laws' is available upon request.

10/92, 5/93, 10/10

1. Other foreign competition laws apply to International Copper Association, Ltd. (ICA)'s activities worldwide.

Copper Demand in Power Electronic Devices

Luke Gear, Senior Technology Analyst



Booming EV Market Brings Opportunities

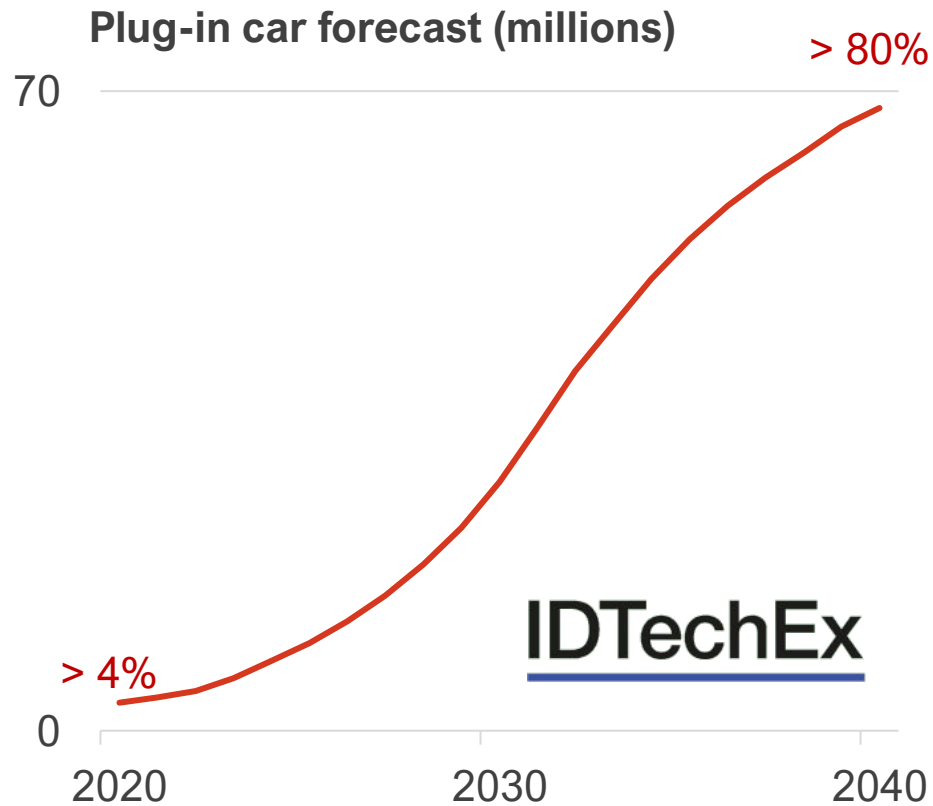

Forecast calculated in 2021. Source: IDTechEx

Electric car markets are booming – growing from just over 4% of the global auto market today to over 80% in 2040 (IDTechEx).

As a result, many new materials opportunities are emerging in the electric vehicle supply chain. In this presentation we focus on power electronics, critical for the operation of EVs and renewables, and a focal point for innovation in itself representing a plethora of new materials opportunity.

What is 'Power Electronics' in an Electric Vehicle

'Power electronics' is the control and conversion of power using solid-state electronics. For electric vehicles, power electronics devices include the onboard charger, the main inverter and DC DC converters.

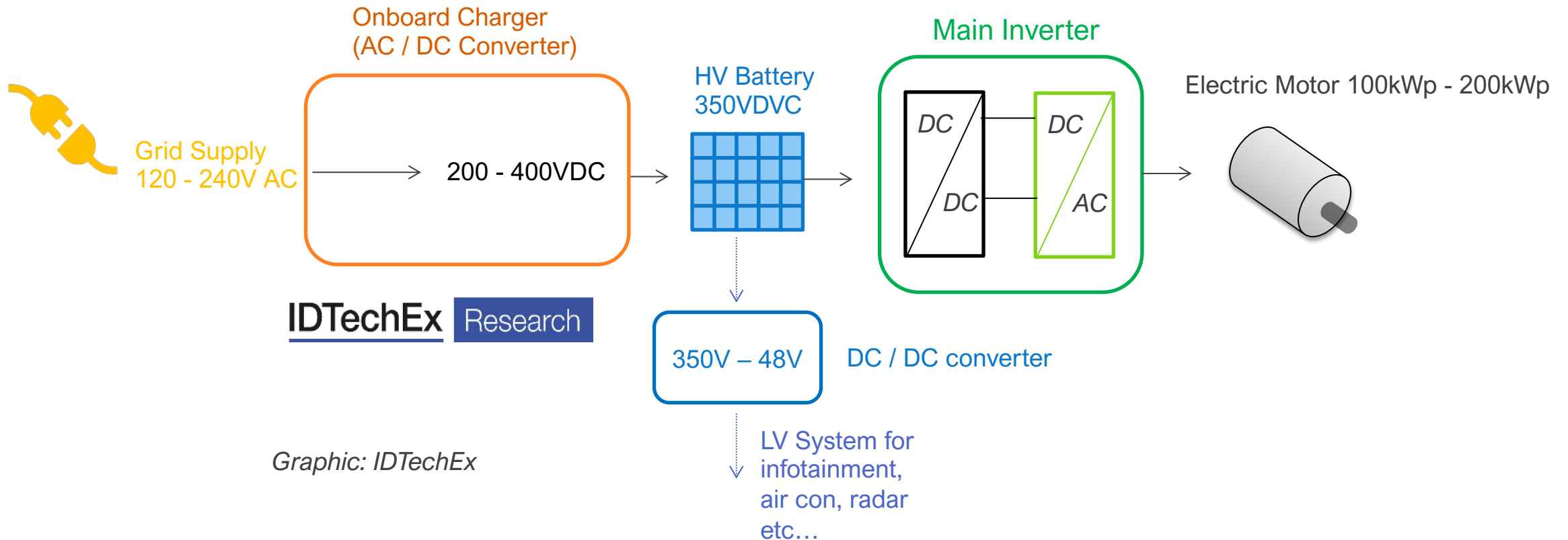

The Transition to Silicon Carbide (SiC) & Gallium Nitride (GaN)

- High temperature operation - greater areal power density and reduction in die area / package size.
- High frequency operation - potential for smaller passive components such as capacitors.
- High voltage operation is a trend in premium EVs (Porsche Taycan, Lucid Air at 800-900V). It enables downsizing of cables allowing weight savings, and faster charging.

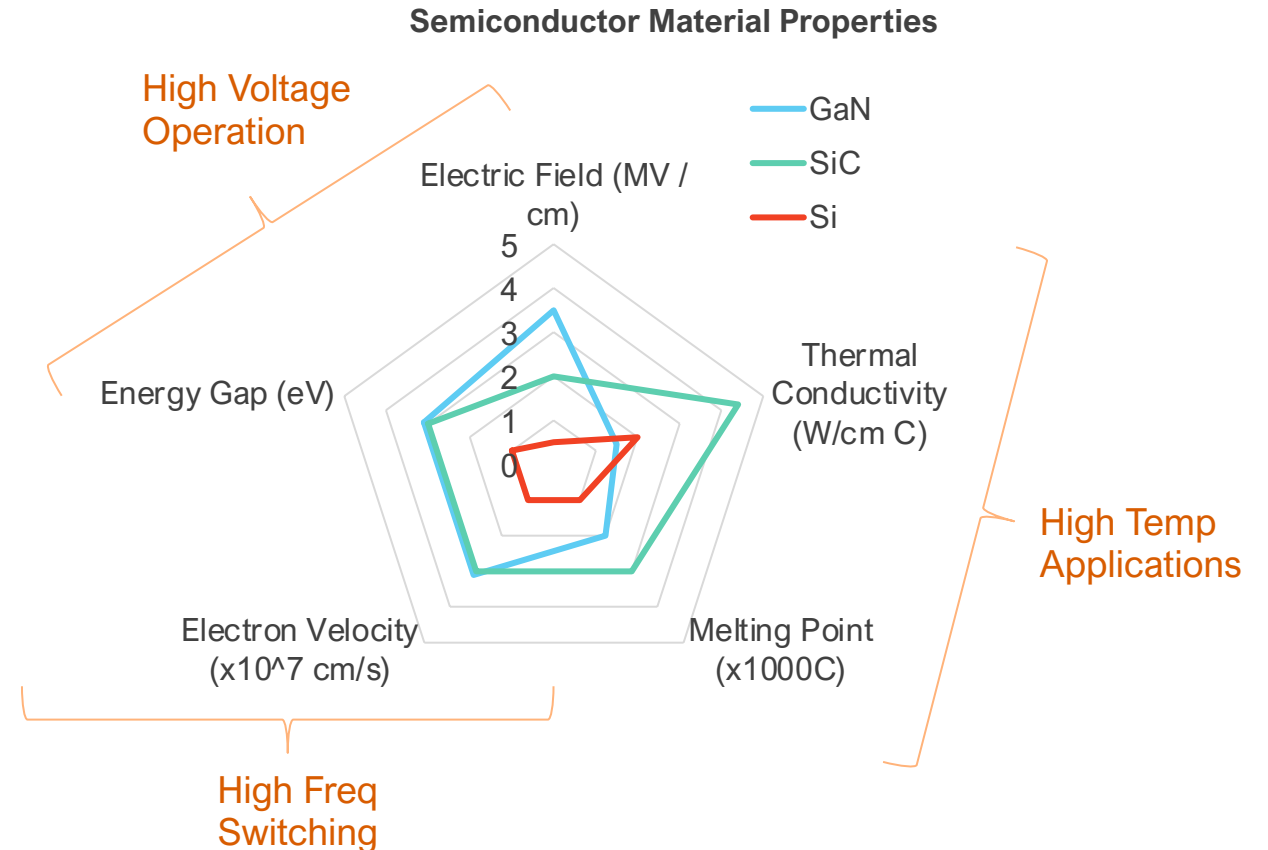

Data source: InRel - NPower

Applications for Silicon Carbide & Gallium Nitride

Inverters and converters in electric vehicles, wind turbines and commercial solar farms are facing a transition to Silicon Carbide.

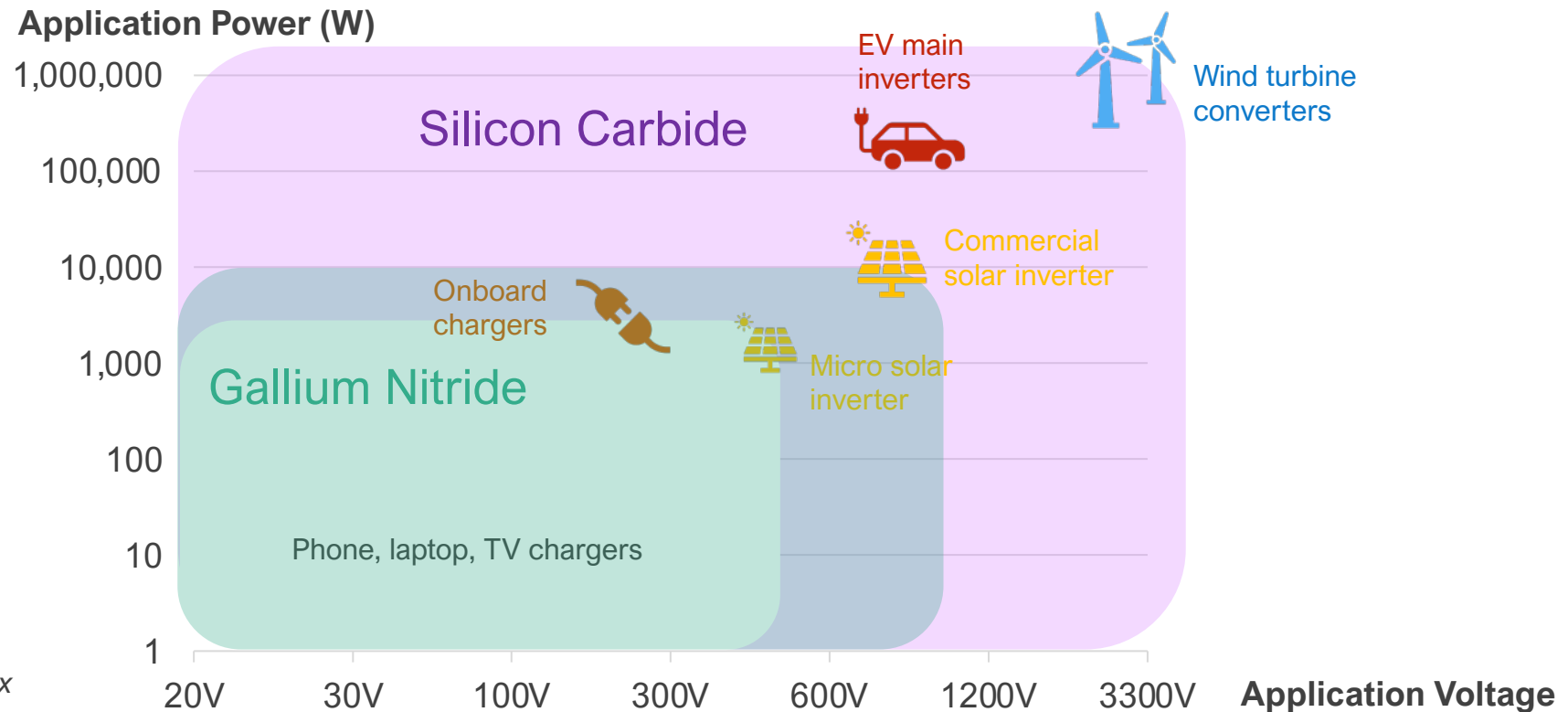

Graphic: IDTechEx

The Transition so Far

Silicon Carbide inverters are adopted across a variety of electric vehicles.

- Tesla Model 3 (350V) (2018)
- Tesla Model Y (2020)
- BYD Han (Q3 2020).
- Tesla Model X and S refresh (2021)
- Lucid Air (900V) (H1 2021).
- Delphi is supplying a 'major OEM' with SiC inverters from 2022. VW? (Audi e-tron, Porsche Taycan at 800V...)

The general trend to higher voltages (> 800V) in cars and heavy-duty vehicles will help drive SiC MOSFET inverter uptake.

Market share of main inverters which use Silicon Carbide (SiC) in electric cars

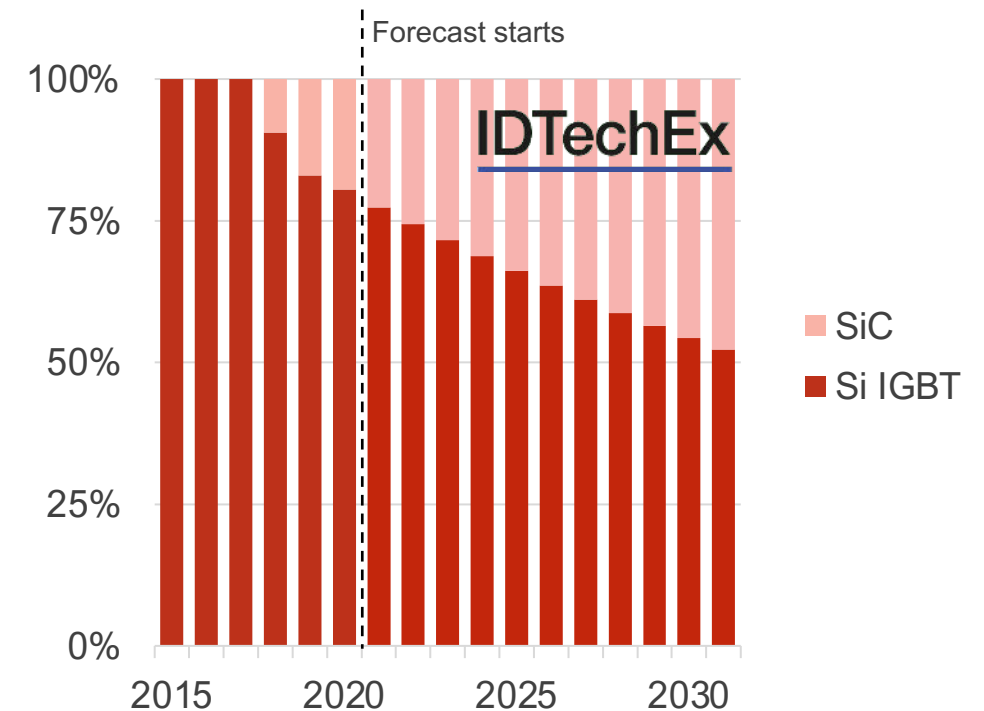

Source: IDTechEx

Inverter & Power Module Packages

The main active component of the inverter is the power module packaging. Alongside busbars, wires and connection plates, this is a key source of copper in the inverter.

Si IGBT Inverter Package

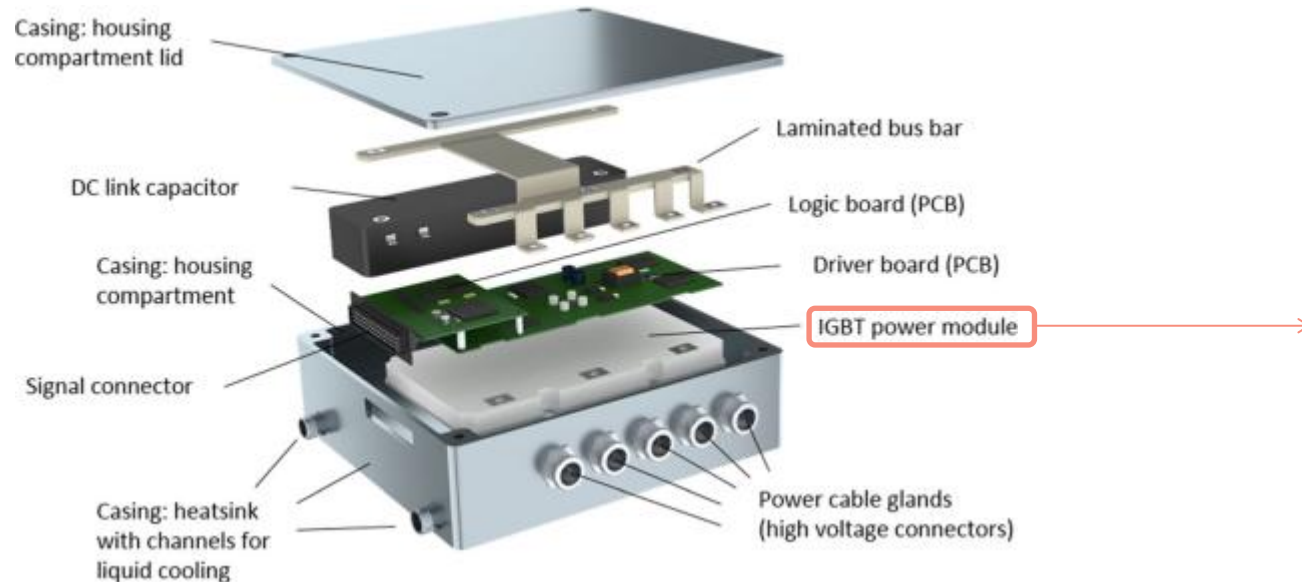

Power Module Package



Open view of standard Si IGBT power modules from Infineon.
Source: Munro & Associates

Exploded sketch of a typical inverter. Source: *The International Journal of Life Cycle Assessment* (2019) 24:78–92

Where is Cu in a Power Module Package?

Below we show a schematic cross section of a conventional Si IGBT package.

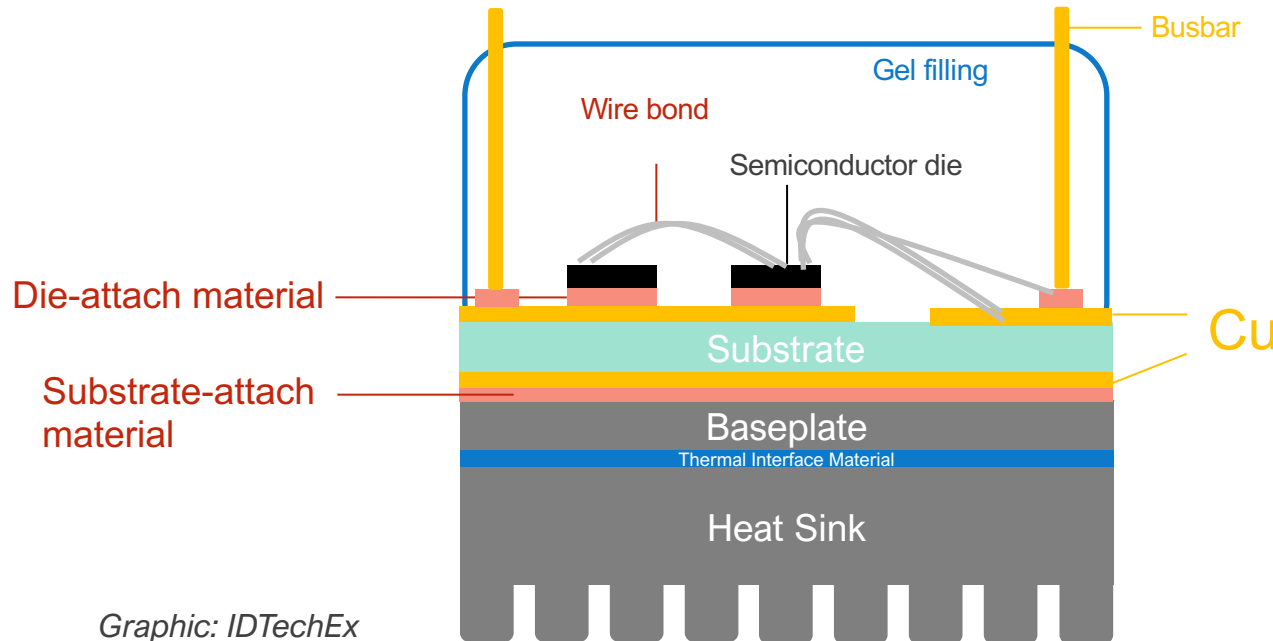

Graphic: IDTechEx

New material opportunities

Die: transition towards Silicon Carbide

Wire bonding: going beyond Al bonding towards Cu bonding or wire bonding-free methods.

Substrate: Higher performance ceramics or metal insulator substrates.

Thermal grease: eliminate if possible, especially in direct cooling

Cooling: transition to double-sided cooling.

Die-attach: transition away from solder e.g. Ag sintered material.

Substrate-attach: might require non-solder solution in very demanding conditions.

Size Reductions to Inverter Package

With the release of the Model 3 in 2018, Tesla became the first company to add SiC metal-oxide-semiconductor field effect transistors (MOSFETs), sourced from ST Microelectronics, in an in-house inverter design.

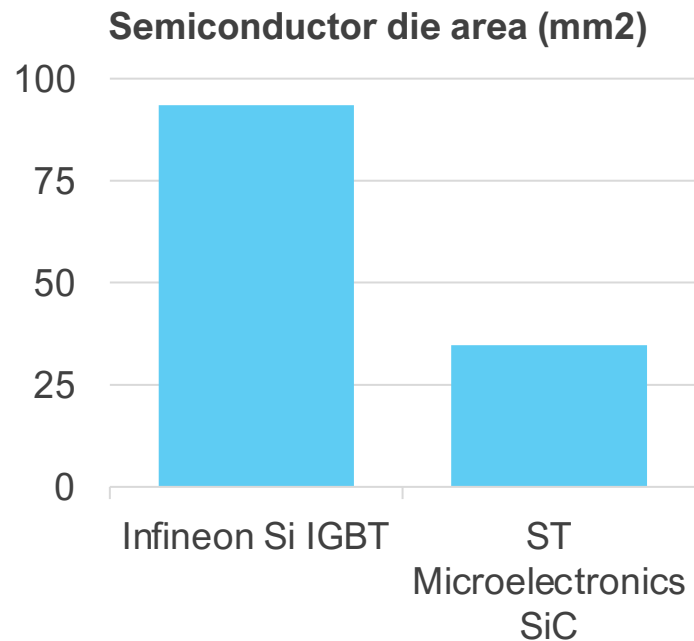

Source: IDTechEx

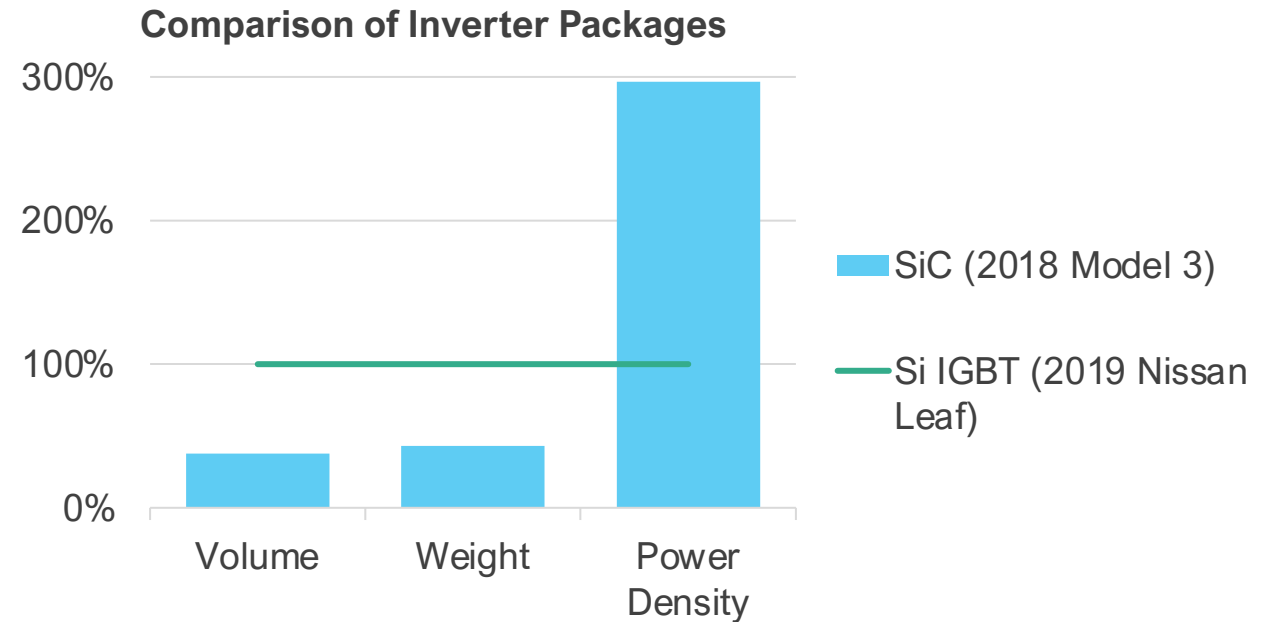

Source: Munro & Associates, IDTechEx

Copper Lead Frames Replace Aluminum

Cu lead frames are an emerging technique, used by Tesla and introduced by Mitsubishi, to replace the multiple wire bonds that allow the semiconductor chips to communicate. Al wire bonds are a common point of failure with power cycling, whereas Cu lead bonding lasts up to 10x longer by eliminating the highly localized hot spots on the chip surface.

Cu in Tesla SiC Inverter (based on grams)

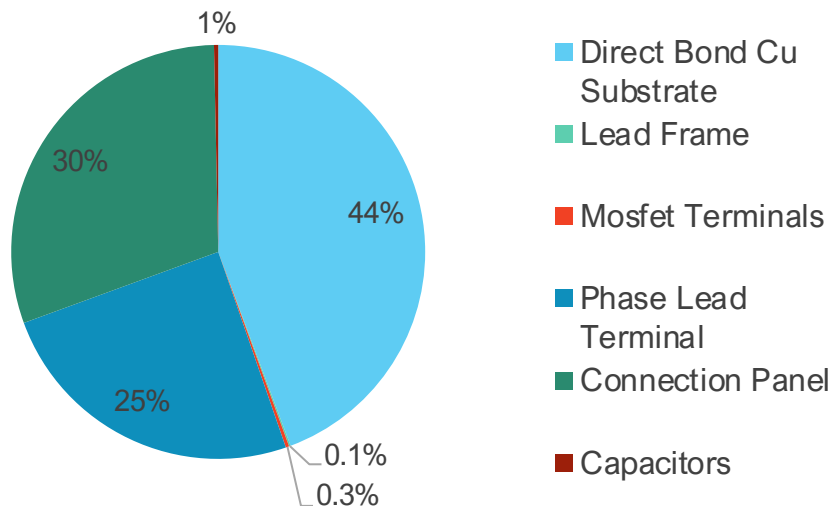

Source: IDTechEx

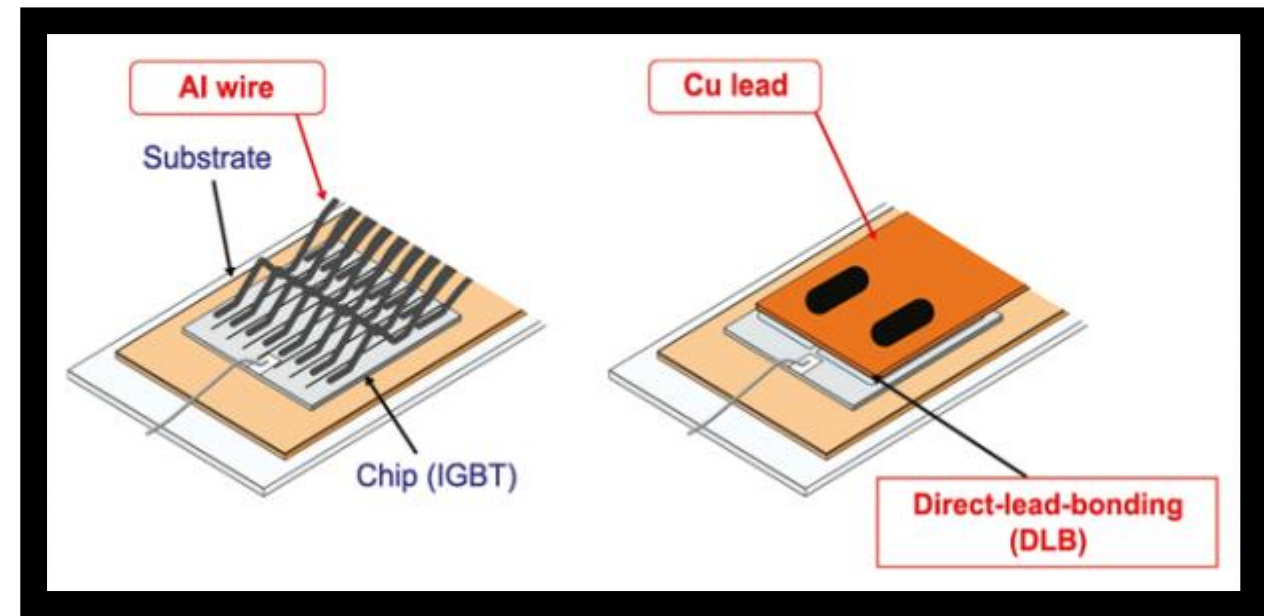
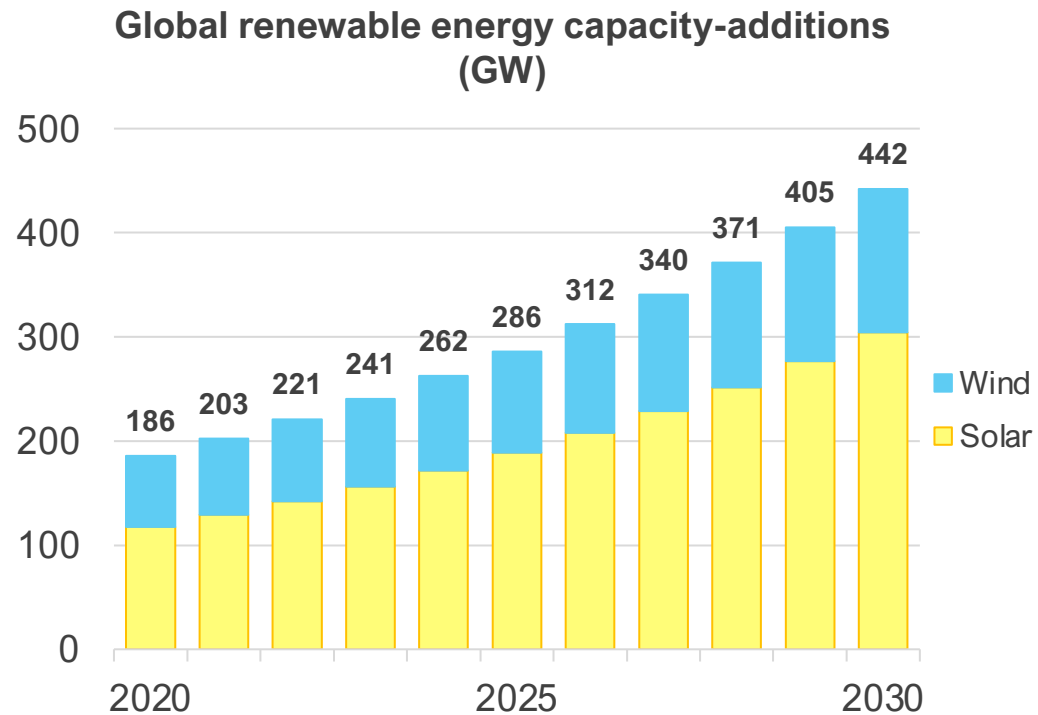

Image source: chargedEVs, Mitsubishi Electric

Capacity-additions by Power Rating: Wind, Solar, EVs

Below power output capacity additions of wind and solar is compared with the combined motor output of electric cars each year. Electric cars, wind and solar farms have inverters with a copper intensity (kg per kW) - copper demand is proportional to these forecasts.



Based on an IDTechEx regression analysis of IRENA, IEA, DNG.VL forecasts. Source: IDTechEx

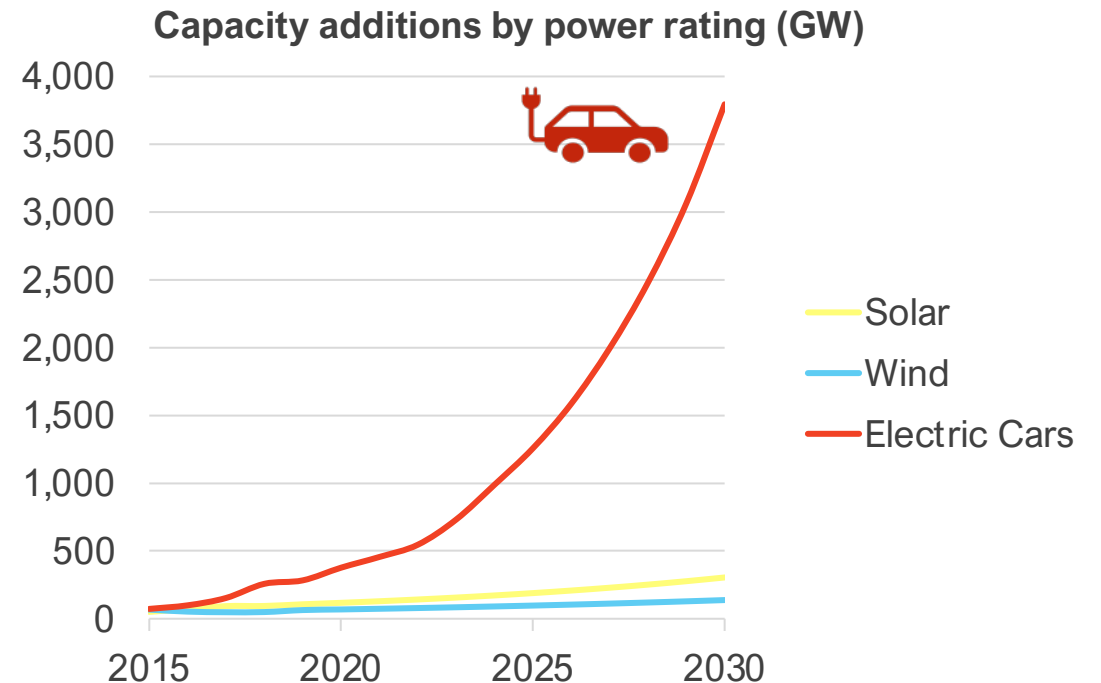

Source: IDTechEx

Copper Demand in Power Electronics Devices

- In 2030, around 20kT of Cu per year will be required for renewable energy and electric car power electronics devices.

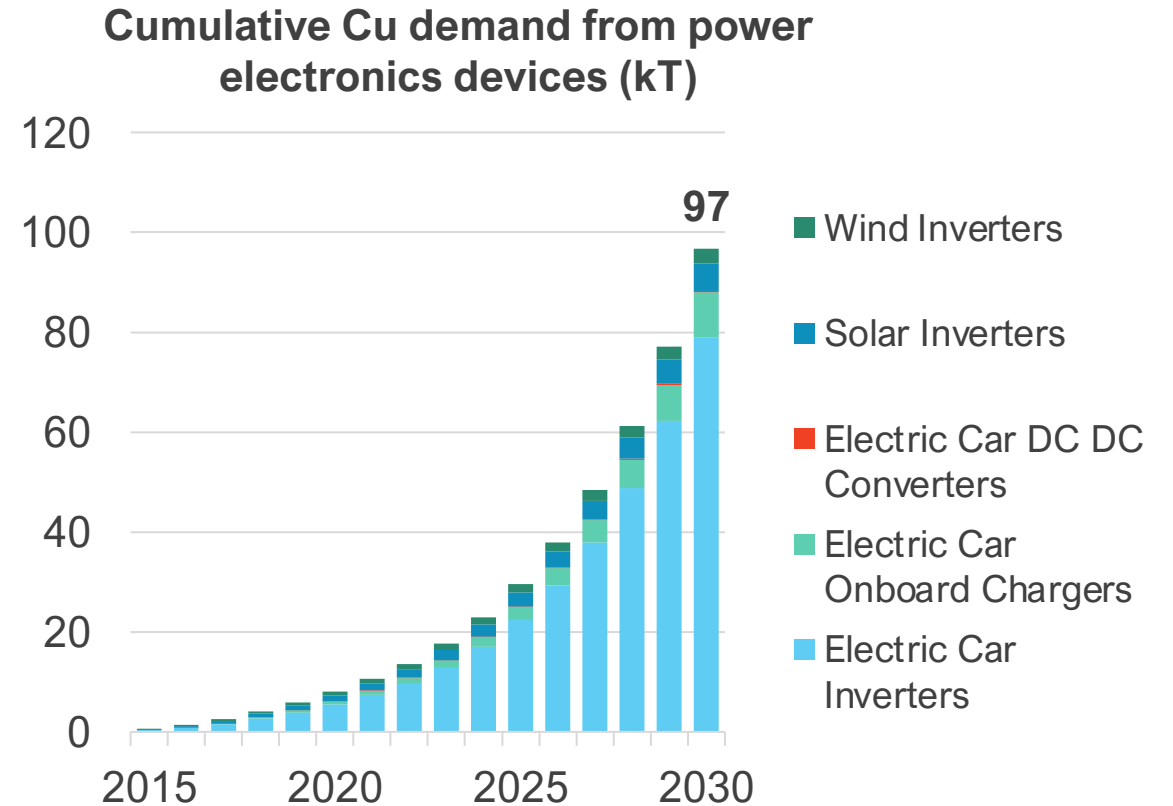
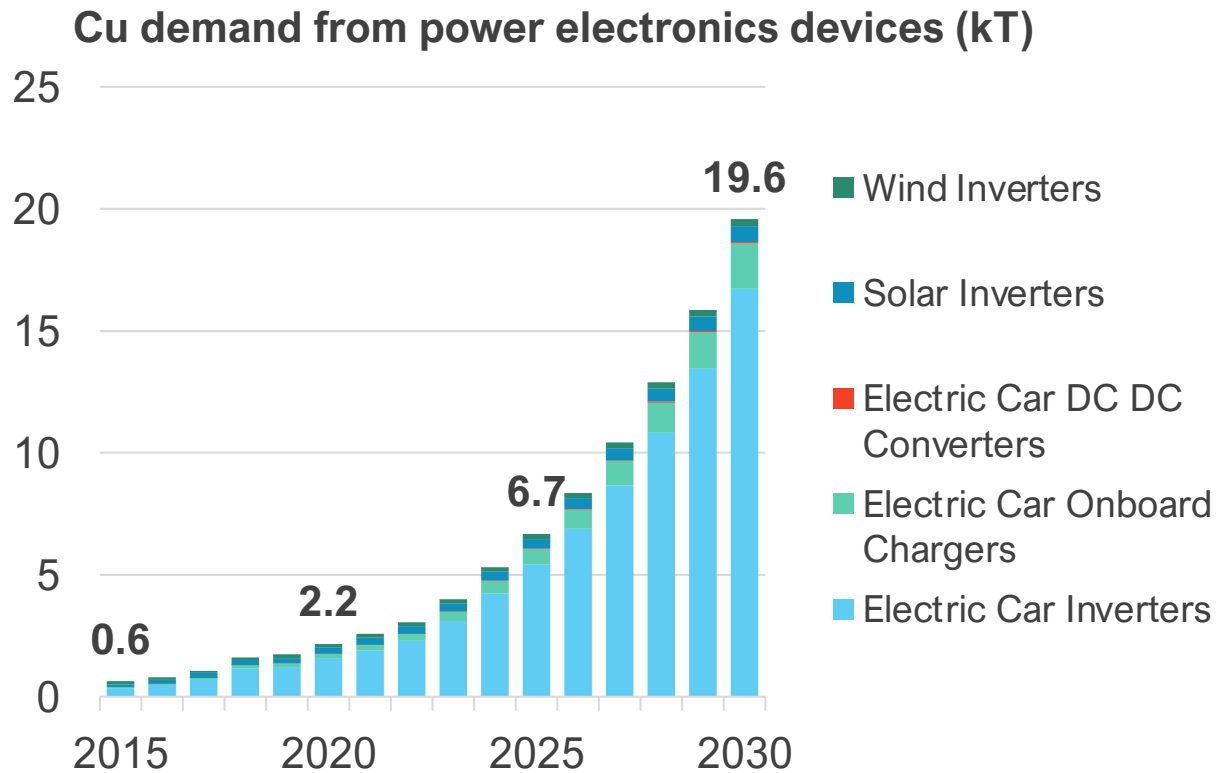

'Electric car' includes plug-in hybrid and pure battery-electric cars. Wind farm converters not included. Source: IDTechEx

Long-term Snapshot

- In 2040, 45kT of Cu per year will be required for electric car inverters.

Cu demand from electric car inverters (kT)

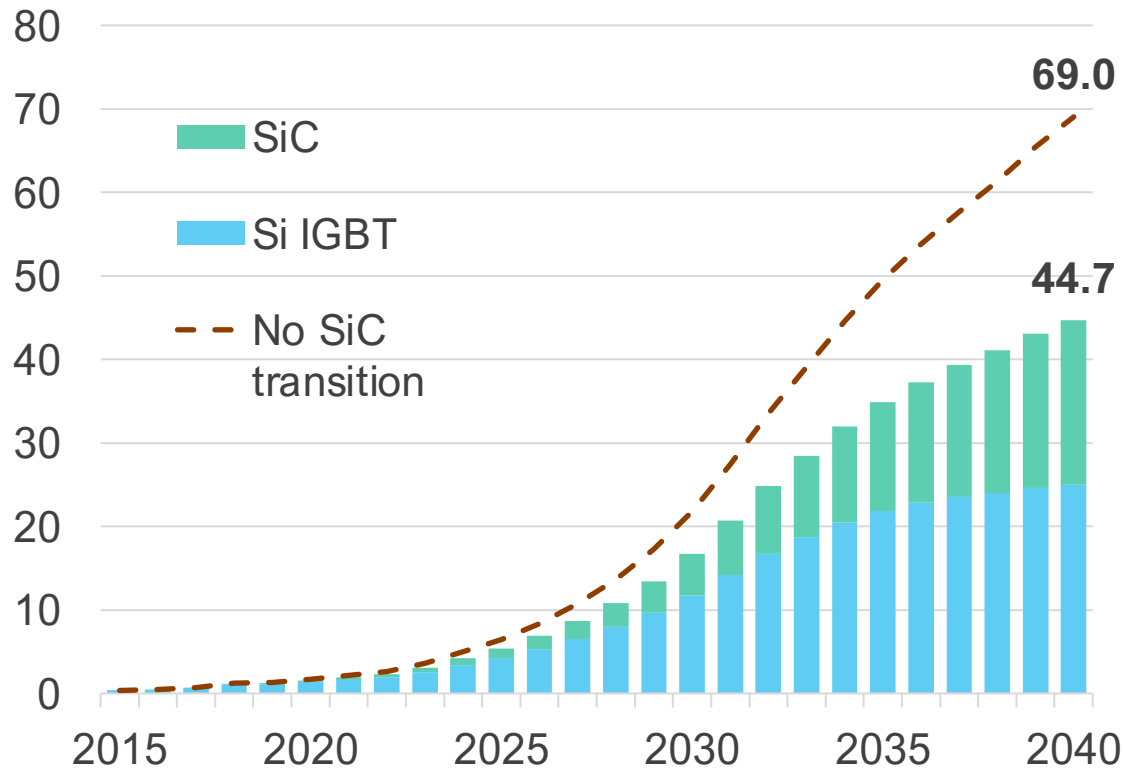

Cumulative Cu demand from electric car inverters (kT)

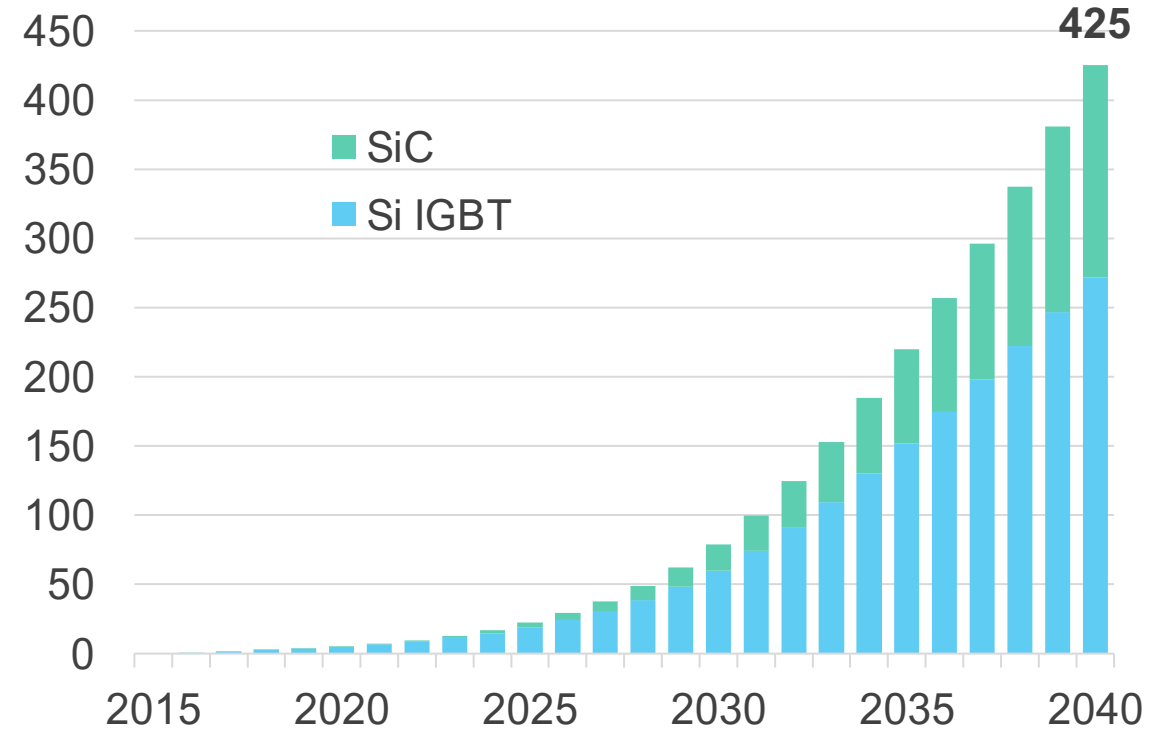

'Electric car' includes plug-in hybrid and pure battery electric cars. Source: IDTechEx